



Power Tools



Lift Assists



Torque Tubes

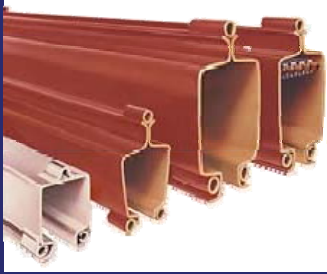

Overhead Rail



Torque Arms



Hoists



Articulating Arms



Design



Multiple Nutrunners



Installation Services

Products and Services



ASSEMBLY TOOL AND MATERIAL HANDLING SPECIALISTS

Rode Tool & Hoist

Rode Tool & Hoist

Rode Tool & Hoist is a full service manufacturer and distributor of material handling equipment. Rode Tool & Hoist is the exclusive Midwest distributor for Bosch Production Tools, Inc. and Bosch Rexroth tightening products. Located in Angola, Indiana, we specialize in fastening, torque reaction and parts handling solutions. Our experienced staff has been providing assembly tool and material handling solutions to the (MVI) motor vehicle and (GI) general industry markets for over 20 years. The name brand products and services we provide are widely used by today's leading manufacturers.



Our engineered products and services are designed to increase productivity, improve quality, and enhance the ergonomics of your manufacturing operation. From start to finish, our design team will work with you to develop the best solution for your needs.

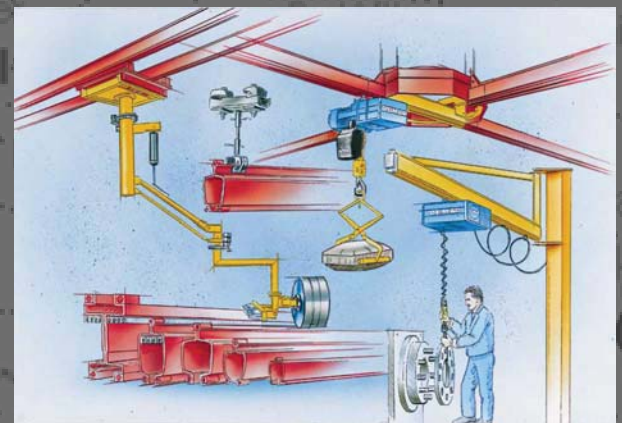

Require installation or start up support? No problem! Rode Tool & Hoist provides turnkey installation services.

We are committed to total customer satisfaction.

Call us toll free at 1-866-665-2067 or

Products and Services

Products and Services we provide include, but are not limited to:

Power Tools

Bosch Production Tools

Cordless Screwdrivers

Cordless Angle Wrenches

Bluetooth Controlled

Pneumatic Screwdrivers

Pulse Tools

Angle Tools

Bosch Rexroth

Handheld DC Electric Tools

Fixtured DC Electric Tools

DC Press Fit Systems

Torque Testing Equipment

Schatz

Crane Electronics

Torque Readout Boxes

Rotary Transducers

Stationary Transducers

Static Torque Wrenches

Static Screwdrivers

Mobile Torque Carts

Crowsfoot & Tubenut Attachments

Lubbering

Jemms Cascade

Automatic Feeders

Assembly Automation

Other Products

Power Tool Repair

Power Tool Validation

Manufactured Products

Torque Tubes

Specialty Tool Holders

Torque Arms

Linear Arms

Multiple Nutrunners

Vacuum Handling Devices

Clamp Handling Devices

Articulating Arms

Simple Hook Devices

Concept and Design

Turnkey Installation Services

Proudly made in Angola, Indiana



Material Handling

Unified Industries, Inc.

DEMAG Cranes & Components

Gorbel

Aluminum Rail

Steel Rail

Freestanding Structures

Jib Cranes

Hoists

visit us online at www.rodetool.com

Manufactured Products

Torque Tubes



The Torque Tube protects the operator from nutrunner torque reaction. Torque tubes offer zero gravity balancing for single and multiple spindle nutrunners.

- Standard models available up to 575 Nm
- Custom travel distances, higher torque models and balancing capacities are available

Special Tool Holders



Trombone Tool

Standard and custom tool holders available for all name brand power tools.

Scissor Tool



Rotational Tool Holder



Fixed Tool Holder

Call us toll free at 1-866-665-2067 or

Proudly Made in USA

Torque Arms

Torque Arms increase fastening accuracy and consistency. Eliminates torque reaction and operator fatigue. Also provides zero gravity tool balancing.

- Standard models available up to 575 Nm
- Bench, Floor, Column, and Carriage mounted models
- Custom reach, travel, and high torque models available

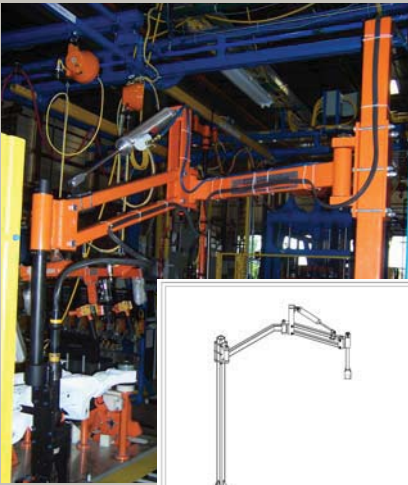

Multiple Nutrunners

Designed to increase productivity

- Fixed and adjustable centers
- For use with right angle and inline tools
- Electric and pneumatic models
- Designed for all name brand power tools



Linear Rail

Used when torque tubes or torque arms are not practical. Keeps the operator's work area efficient and absorbs torque reaction.

visit us online at www.rodetool.com

Manufactured Products

Lift Assists

Vacuum Handling

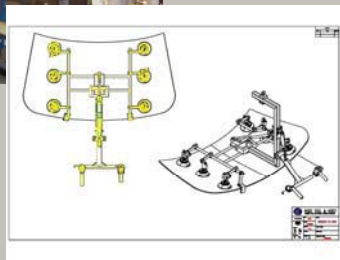
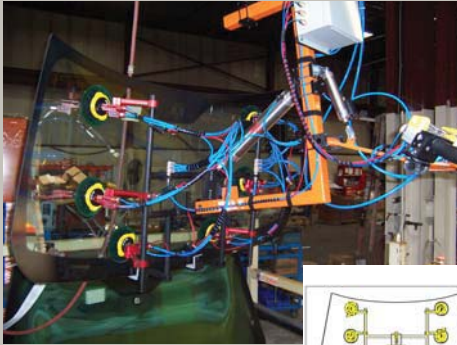

Customer built vacuum and clamp handling devices for a wide variety of applications. Built to improve worker safety and to increase productivity. Simple Hooks are designed to be uncomplicated, durable, and cost effective.

Clamp Handling

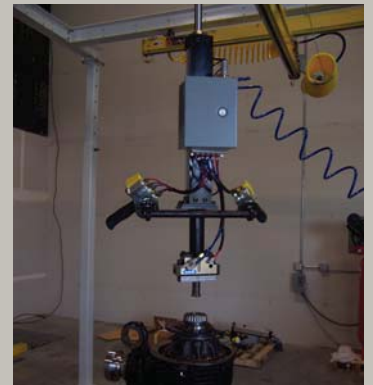
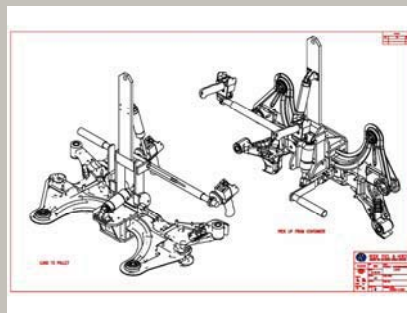

Simple Hooks

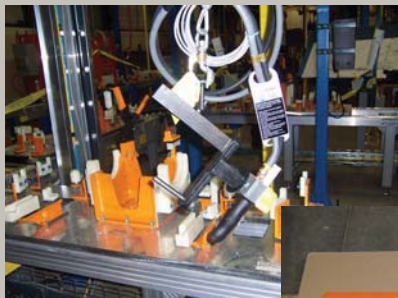

Call us toll free at 1-866-665-2067 or

Proudly Made in USA

Articulating Arms



Articulating Arms are designed for applications that require extended reach or for the handling of offset loads. Articulating arms are used when the use of a standard hoist is not practical. Custom end effectors are designed to fit your needs.



Internal Electrification

Enclosed Rail



Telescoping Rail



Electric Hoist



Simple Hooks



UNIFIED INDUSTRIES INC.



Jib Cranes



Freestanding Systems



Tractor Drives

visit us online at www.rodetool.com



CORPORATE
HEADQUARTERS
855 N 275 W
Angola, IN 46703

Toll Free:
1-866-665-2067
www.rodetool.com

